

# Data Sheet



Article number: 5863503813

Description: Ball Valve 350.3813, G 1 1/4" - G 1 1/4"  
Thread/Thread

## Measures

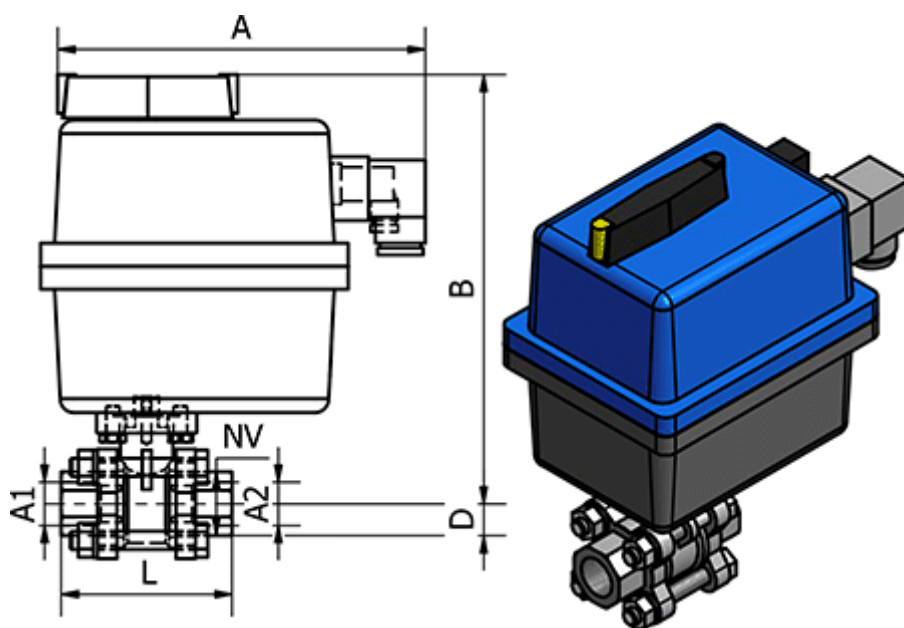

= -	Connecting A2	= G 1 1/4"
= -	D	= 37
= -	L	= 91
= -	Max. Operating Pressure	= 40 bar
= -	NV	= 41

A = 177

B = 205

Connecting A1 = G 1 1/4"